





Grayhill, Inc.

**62S11-N3-PH**

Part Number:	62S11-N3-PH
Manufacturer/Brand:	Grayhill, Inc.
Product description:	ROTARY ENCODER OPTICAL 32PPR
Datasheets:	 <a href="#">62S11-N3-PH.pdf</a>
RoHS Status:	 Lead free / RoHS Compliant
Stock Condition:	1856 pcs stock
Ship From:	Hong Kong
Shipment Way:	DHL/Fedex/TNT/UPS/EMS



[REQUEST FOR QUOTATION](#)

Image may be representation. See specifications for product details.

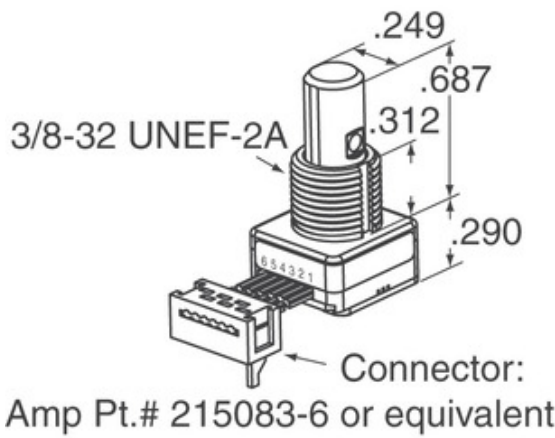

## Specifications of 62S11-N3-PH

PART NUMBER	62S11-N3-PH
MANUFACTURER	Grayhill, Inc.
DESCRIPTION	ROTARY ENCODER OPTICAL 32PPR
LEAD FREE STATUS / ROHS STATUS	Lead free / RoHS Compliant
QUANTITY AVAILABLE	1856 pcs
DATA SHEET	 <a href="#">62S11-N3-PH.pdf</a>
VOLTAGE - SUPPLY	5V
TERMINATION STYLE	PC Pin
SERIES	62S
ROTATIONAL LIFE (CYCLES MIN)	1M
PULSES PER REVOLUTION	32
OUTPUT TYPE	Quadrature (Incremental)
OTHER NAMES	62S11N3PH
ORIENTATION	Vertical
MOUNTING TYPE	PCB, Through Hole
MOISTURE SENSITIVITY LEVEL (MSL)	1 (Unlimited)
LEAD FREE STATUS / ROHS STATUS	Lead free / RoHS Compliant
ENCODER TYPE	Optical
DETENT	No
BUILT IN SWITCH	Yes
ACTUATOR TYPE	1/4" Dia Flatted End

## Related Tags

Grayhill, Inc. 62S11-N3-PH	62S11-N3-PH Distributor	62S11-N3-PH Supplier
62S11-N3-PH Price	62S11-N3-PH Pictures	62S11-N3-PH Image
62S11-N3-PH PDF Datasheet	62S11-N3-PH Download Datasheet	62S11-N3-PH Datasheet
62S11-N3-PH Stock	Buy 62S11-N3-PH	Buy Grayhill, Inc. 62S11-N3-PH
Grayhill, Inc. 62S11-N3-PH	Grayhill, Inc. Supplier	Grayhill, Inc. Distributor
Grayhill, Inc. 62S11-N3-PH	Grayhill Inc. 62S11-N3-PH	

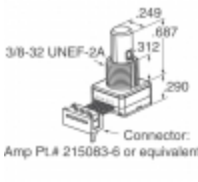
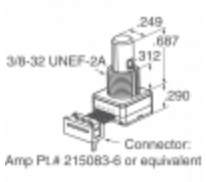
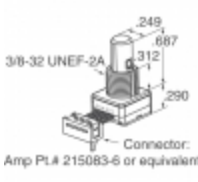
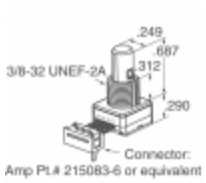
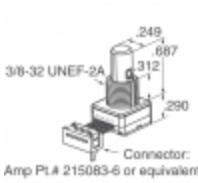
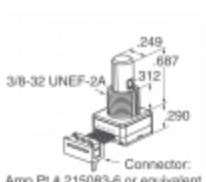
## Related Products

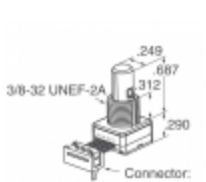
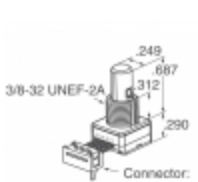
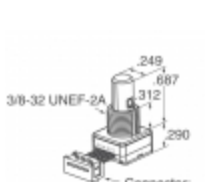
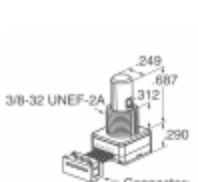
 <p><b>62S11-N4-020C</b> Manufacturers: Grayhill, Inc. Description: ROTARY ENCODER OPTICAL 32PPR In stock: 2083 pcs</p> <p><a href="#">RFQ</a></p>	 <p><b>62S11-N4-P</b> Manufacturers: Grayhill, Inc. Description: ROTARY ENCODER OPTICAL 32PPR In stock: 1912 pcs</p> <p><a href="#">RFQ</a></p>
 <p><b>62S11-N2-030C</b> Manufacturers: Grayhill, Inc. Description: ROTARY ENCODER OPTICAL 32PPR In stock: 1773 pcs</p> <p><a href="#">RFQ</a></p>	 <p><b>62S11-N4-120S</b> Manufacturers: Grayhill, Inc. Description: ROTARY ENCODER OPTICAL 32PPR In stock: 2038 pcs</p> <p><a href="#">RFQ</a></p>
 <p><b>62S11-N4-025CH</b> Manufacturers: Grayhill, Inc. Description: ROTARY ENCODER OPTICAL 32PPR In stock: 1946 pcs</p> <p><a href="#">RFQ</a></p>	 <p><b>62S11-N0-PH</b> Manufacturers: Grayhill, Inc. Description: ROTARY ENCODER OPTICAL 32PPR In stock: 2260 pcs</p> <p><a href="#">RFQ</a></p>
 <p><b>62S11-N2-P</b> Manufacturers: Grayhill, Inc. Description: ROTARY ENCODER OPTICAL 32PPR In stock: 2376 pcs</p> <p><a href="#">RFQ</a></p>	 <p><b>62S11-N4-025C</b> Manufacturers: Grayhill, Inc. Description: ROTARY ENCODER OPTICAL 32PPR In stock: 1970 pcs</p> <p><a href="#">RFQ</a></p>
 <p><b>62S11-N2-040C</b> Manufacturers: Grayhill, Inc. Description: ROTARY ENCODER OPTICAL 32PPR In stock: 2333 pcs</p> <p><a href="#">RFQ</a></p>	 <p><b>62S11-N4-060SH</b> Manufacturers: Grayhill, Inc. Description: ROTARY ENCODER OPTICAL 32PPR In stock: 2262 pcs</p> <p><a href="#">RFQ</a></p>
 <p><b>62S11-N2-PH</b> Manufacturers: Grayhill, Inc. Description: ROTARY ENCODER OPTICAL 32PPR In stock: 1760 pcs</p> <p><a href="#">RFQ</a></p>	 <p><b>62S11-N0-PHV</b> Manufacturers: Grayhill, Inc. Description: ROTARY ENCODER OPTICAL 32PPR In stock: 2020 pcs</p> <p><a href="#">RFQ</a></p>

Copyright © 2020 Reliable Distributor of Electronic Components

E-mail: [Info@infinity-electronic.com](mailto:Info@infinity-electronic.com)

Address: 17F, Gaylord Commercial Building, 114-118 Lockhart Road, Wan Chai, Hong Kong

