





Grayhill, Inc.

**62S11-N4-PH**

Part Number:	62S11-N4-PH
Manufacturer/Brand:	Grayhill, Inc.
Product description:	ROTARY ENCODER OPTICAL 32PPR
Datasheets:	 <a href="#">62S11-N4-PH.pdf</a>
RoHS Status:	 Lead free / RoHS Compliant
Stock Condition:	1970 pcs stock
Ship From:	Hong Kong
Shipment Way:	DHL/Fedex/TNT/UPS/EMS



[REQUEST FOR QUOTATION](#)

Image may be representation. See specifications for product details.





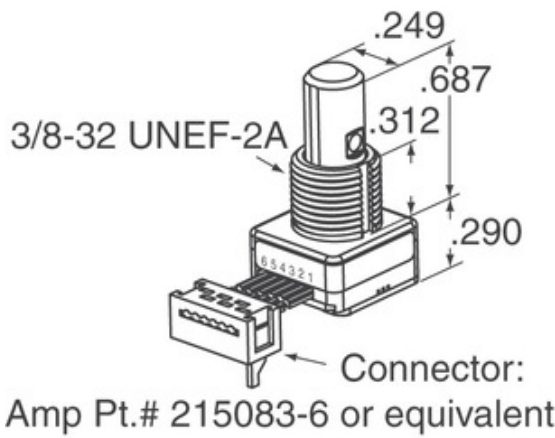

## Specifications of 62S11-N4-PH

PART NUMBER	62S11-N4-PH
MANUFACTURER	Grayhill, Inc.
DESCRIPTION	ROTARY ENCODER OPTICAL 32PPR
LEAD FREE STATUS / ROHS STATUS	Lead free / RoHS Compliant
QUANTITY AVAILABLE	1970 pcs
DATA SHEET	 <a href="#">62S11-N4-PH.pdf</a>
VOLTAGE - SUPPLY	5V
TERMINATION STYLE	PC Pin
SERIES	62S
ROTATIONAL LIFE (CYCLES MIN)	1M
PULSES PER REVOLUTION	32
OUTPUT TYPE	Quadrature (Incremental)
OTHER NAMES	62S11N4PH
ORIENTATION	Vertical
MOUNTING TYPE	PCB, Through Hole
MOISTURE SENSITIVITY LEVEL (MSL)	1 (Unlimited)
LEAD FREE STATUS / ROHS STATUS	Lead free / RoHS Compliant
ENCODER TYPE	Optical
DETENT	No
BUILT IN SWITCH	Yes
ACTUATOR TYPE	1/4" Dia Flatted End

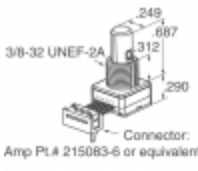
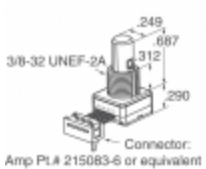
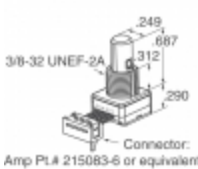
## Related Tags

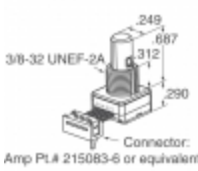
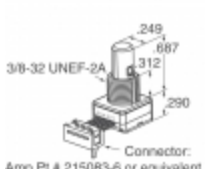
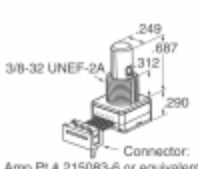
<a href="#">Grayhill, Inc. 62S11-N4-PH</a>	<a href="#">62S11-N4-PH Distributor</a>	<a href="#">62S11-N4-PH Supplier</a>
<a href="#">62S11-N4-PH Price</a>	<a href="#">62S11-N4-PH Pictures</a>	<a href="#">62S11-N4-PH Image</a>
<a href="#">62S11-N4-PH PDF Datasheet</a>	<a href="#">62S11-N4-PH Download Datasheet</a>	<a href="#">62S11-N4-PH Datasheet</a>
<a href="#">62S11-N4-PH Stock</a>	<a href="#">Buy 62S11-N4-PH</a>	<a href="#">Buy Grayhill, Inc. 62S11-N4-PH</a>
<a href="#">Grayhill, Inc. 62S11-N4-PH</a>	<a href="#">Grayhill, Inc. Supplier</a>	<a href="#">Grayhill, Inc. Distributor</a>
<a href="#">Grayhill, Inc. 62S11-N4-PH</a>	<a href="#">Grayhill Inc. 62S11-N4-PH</a>	

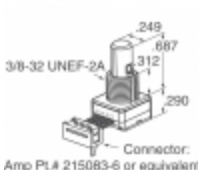
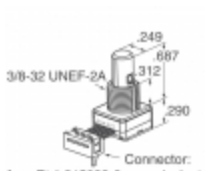
## Related Products

 <p><b>62S11-N4-025C</b> Manufacturers: Grayhill, Inc. Description: ROTARY ENCODER OPTICAL 32PPR In stock: 1970 pcs</p> <p><a href="#">RFQ</a></p>	 <p><b>62S11-N4-120S</b> Manufacturers: Grayhill, Inc. Description: ROTARY ENCODER OPTICAL 32PPR In stock: 2038 pcs</p> <p><a href="#">RFQ</a></p>
 <p><b>62S11-N4-025CH</b> Manufacturers: Grayhill, Inc. Description: ROTARY ENCODER OPTICAL 32PPR In stock: 1946 pcs</p> <p><a href="#">RFQ</a></p>	 <p><b>62S11-N5-060SH</b> Manufacturers: Grayhill, Inc. Description: ROTARY ENCODER OPTICAL 32PPR In stock: 2263 pcs</p> <p><a href="#">RFQ</a></p>
 <p><b>62S11-N4-020C</b> Manufacturers: Grayhill, Inc. Description: ROTARY ENCODER OPTICAL 32PPR In stock: 2083 pcs</p> <p><a href="#">RFQ</a></p>	 <p><b>62S11-N5-060C</b> Manufacturers: Grayhill, Inc. Description: ROTARY ENCODER OPTICAL 32PPR In stock: 2164 pcs</p> <p><a href="#">RFQ</a></p>
 <p><b>62S11-N4-P</b> Manufacturers: Grayhill, Inc. Description: ROTARY ENCODER OPTICAL 32PPR In stock: 1912 pcs</p> <p><a href="#">RFQ</a></p>	 <p><b>62S11-N5-050C</b> Manufacturers: Grayhill, Inc. Description: ROTARY ENCODER OPTICAL 32PPR In stock: 1936 pcs</p> <p><a href="#">RFQ</a></p>
 <p><b>62S11-N5-025CH</b> Manufacturers: Grayhill, Inc. Description: ROTARY ENCODER OPTICAL 32PPR In stock: 2083 pcs</p> <p><a href="#">RFQ</a></p>	 <p><b>62S11-N5-040C</b> Manufacturers: Grayhill, Inc. Description: ROTARY ENCODER OPTICAL 32PPR In stock: 2106 pcs</p> <p><a href="#">RFQ</a></p>
 <p><b>62S11-N4-060SH</b> Manufacturers: Grayhill, Inc. Description: ROTARY ENCODER OPTICAL 32PPR In stock: 2262 pcs</p> <p><a href="#">RFQ</a></p>	 <p><b>62S11-N5-025C</b> Manufacturers: Grayhill, Inc. Description: ROTARY ENCODER OPTICAL 32PPR In stock: 2408 pcs</p> <p><a href="#">RFQ</a></p>

Copyright © 2020 Reliable Distributor of Electronic Components

E-mail: [Info@infinity-electronic.com](mailto:Info@infinity-electronic.com)

Address: 17F, Gaylord Commercial Building, 114-118 Lockhart Road, Wan Chai, Hong Kong

