





Grayhill, Inc.

62S11-H9-050S

Part Number:	62S11-H9-050S
Manufacturer/Brand:	Grayhill, Inc.
Product description:	ROTARY ENCODER OPTICAL 32PPR
Datasheets:	 62S11-H9-050S.pdf
RoHS Status:	 Lead free / RoHS Compliant
Stock Condition:	1839 pcs stock
Ship From:	Hong Kong
Shipment Way:	DHL/Fedex/TNT/UPS/EMS



[REQUEST FOR QUOTATION](#)

Image may be representation. See specifications for product details.

Specifications of 62S11-H9-050S

PART NUMBER	62S11-H9-050S
MANUFACTURER	Grayhill, Inc.
DESCRIPTION	ROTARY ENCODER OPTICAL 32PPR
LEAD FREE STATUS / ROHS STATUS	Lead free / RoHS Compliant
QUANTITY AVAILABLE	1839 pcs
DATA SHEET	 62S11-H9-050S.pdf
VOLTAGE - SUPPLY	5V
TERMINATION STYLE	Cable Leads
SERIES	62S
ROTATIONAL LIFE (CYCLES MIN)	1M
PULSES PER REVOLUTION	32
OUTPUT TYPE	Quadrature (Incremental)
OTHER NAMES	62S11H9050S
ORIENTATION	Vertical
MOUNTING TYPE	Panel Mount
MOISTURE SENSITIVITY LEVEL (MSL)	1 (Unlimited)
LEAD FREE STATUS / ROHS STATUS	Lead free / RoHS Compliant
ENCODER TYPE	Optical
DETENT	Yes
BUILT IN SWITCH	Yes
ACTUATOR TYPE	1/4" Dia Flatted End

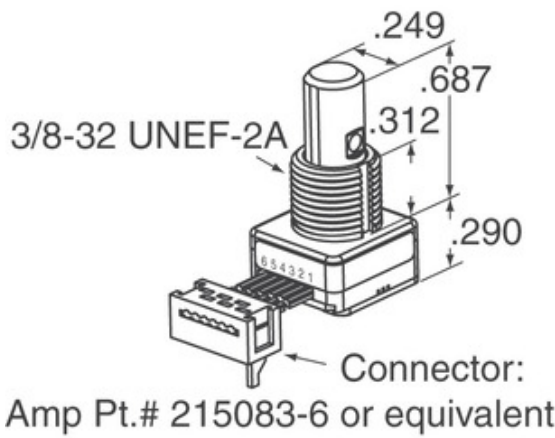
Related Tags

Grayhill, Inc. 62S11-H9-050S	62S11-H9-050S Distributor	62S11-H9-050S Supplier
62S11-H9-050S Price	62S11-H9-050S Pictures	62S11-H9-050S Image
62S11-H9-050S PDF Datasheet	62S11-H9-050S Download Datasheet	62S11-H9-050S Datasheet
62S11-H9-050S Stock	Buy 62S11-H9-050S	Buy Grayhill, Inc. 62S11-H9-050S
Grayhill, Inc. 62S11-H9-050S	Grayhill, Inc. Supplier	Grayhill, Inc. Distributor
Grayhill, Inc. 62S11-H9-050S	Grayhill Inc. 62S11-H9-050S	

Related Products

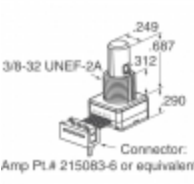
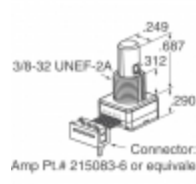
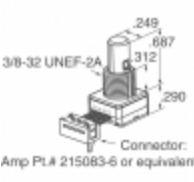
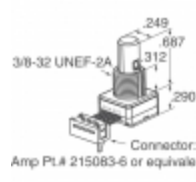
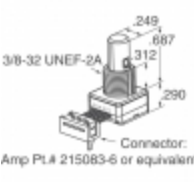
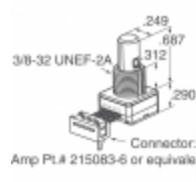
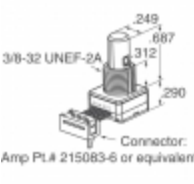
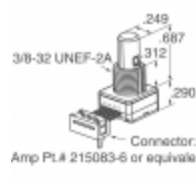
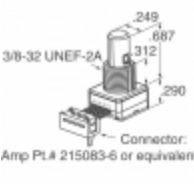
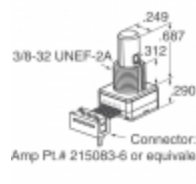
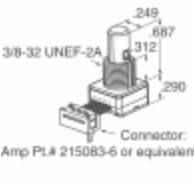
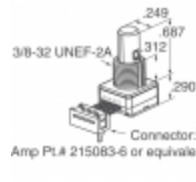
 <p>62S11-L0-020CH Manufacturers: Grayhill, Inc. Description: ROTARY ENCODER OPTICAL 32PPR In stock: 2105 pcs</p> <p>RFQ</p>	 <p>62S11-H9-PH Manufacturers: Grayhill, Inc. Description: ROTARY ENCODER OPTICAL 32PPR In stock: 2090 pcs</p> <p>RFQ</p>
 <p>62S11-H9-060SH Manufacturers: Grayhill, Inc. Description: ROTARY ENCODER OPTICAL 32PPR In stock: 1966 pcs</p> <p>RFQ</p>	 <p>62S11-H9-025S Manufacturers: Grayhill, Inc. Description: ROTARY ENCODER OPTICAL 32PPR In stock: 2155 pcs</p> <p>RFQ</p>
 <p>62S11-H9-020S Manufacturers: Grayhill, Inc. Description: ROTARY ENCODER OPTICAL 32PPR In stock: 2170 pcs</p> <p>RFQ</p>	 <p>62S11-H0-PH Manufacturers: Grayhill, Inc. Description: ROTARY ENCODER OPTICAL 32PPR In stock: 2006 pcs</p> <p>RFQ</p>
 <p>62S11-H9-040S Manufacturers: Grayhill, Inc. Description: ROTARY ENCODER OPTICAL 32PPR In stock: 2086 pcs</p> <p>RFQ</p>	 <p>62S11-H9-060C Manufacturers: Grayhill, Inc. Description: ROTARY ENCODER OPTICAL 32PPR In stock: 2172 pcs</p> <p>RFQ</p>
 <p>62S11-L0-020C Manufacturers: Grayhill, Inc. Description: ROTARY ENCODER OPTICAL 32PPR In stock: 1839 pcs</p> <p>RFQ</p>	 <p>62S11-H9-020C Manufacturers: Grayhill, Inc. Description: ROTARY ENCODER OPTICAL 32PPR In stock: 2176 pcs</p> <p>RFQ</p>
 <p>62S11-H9-P Manufacturers: Grayhill, Inc. Description: ROTARY ENCODER OPTICAL 32PPR In stock: 2159 pcs</p> <p>RFQ</p>	 <p>62S11-H9-040C Manufacturers: Grayhill, Inc. Description: ROTARY ENCODER OPTICAL 32PPR In stock: 1975 pcs</p> <p>RFQ</p>

Copyright © 2020 Reliable Distributor of Electronic Components

E-mail: Info@infinity-electronic.com

Address: 17F, Gaylord Commercial Building, 114-118 Lockhart Road, Wan Chai, Hong Kong

