





Grayhill, Inc.

62S11-N5-050C

Part Number:	62S11-N5-050C
Manufacturer/Brand:	Grayhill, Inc.
Product description:	ROTARY ENCODER OPTICAL 32PPR
Datasheets:	 62S11-N5-050C.pdf
RoHS Status:	 Lead free / RoHS Compliant
Stock Condition:	1936 pcs stock
Ship From:	Hong Kong
Shipment Way:	DHL/Fedex/TNT/UPS/EMS



[REQUEST FOR QUOTATION](#)

Image may be representation. See specifications for product details.



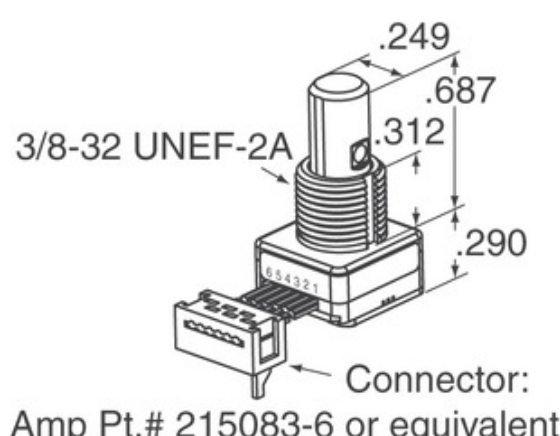

Specifications of 62S11-N5-050C

PART NUMBER	62S11-N5-050C
MANUFACTURER	Grayhill, Inc.
DESCRIPTION	ROTARY ENCODER OPTICAL 32PPR
LEAD FREE STATUS / ROHS STATUS	Lead free / RoHS Compliant
QUANTITY AVAILABLE	1936 pcs
DATA SHEET	 62S11-N5-050C.pdf
VOLTAGE - SUPPLY	5V
TERMINATION STYLE	Cable with Connector
SERIES	62S
ROTATIONAL LIFE (CYCLES MIN)	1M
PULSES PER REVOLUTION	32
OUTPUT TYPE	Quadrature (Incremental)
OTHER NAMES	62S11N5050C
ORIENTATION	Vertical
MOUNTING TYPE	Panel Mount
MOISTURE SENSITIVITY LEVEL (MSL)	1 (Unlimited)
LEAD FREE STATUS / ROHS STATUS	Lead free / RoHS Compliant
ENCODER TYPE	Optical
DETENT	No
BUILT IN SWITCH	Yes
ACTUATOR TYPE	1/4" Dia Flatted End

Related Tags

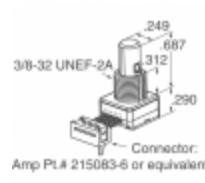
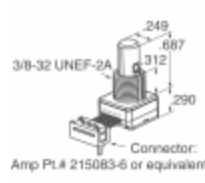
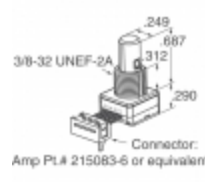
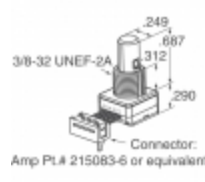
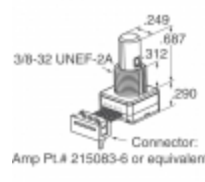
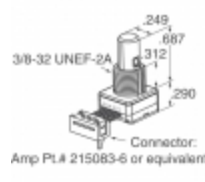
Grayhill, Inc. 62S11-N5-050C	62S11-N5-050C Distributor	62S11-N5-050C Supplier
62S11-N5-050C Price	62S11-N5-050C Pictures	62S11-N5-050C Image
62S11-N5-050C PDF Datasheet	62S11-N5-050C Download Datasheet	62S11-N5-050C Datasheet
62S11-N5-050C Stock	Buy 62S11-N5-050C	Buy Grayhill, Inc. 62S11-N5-050C
Grayhill, Inc. 62S11-N5-050C	Grayhill, Inc. Supplier	Grayhill, Inc. Distributor
Grayhill, Inc. 62S11-N5-050C	Grayhill Inc. 62S11-N5-050C	

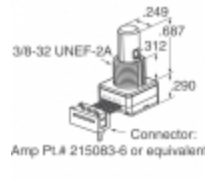
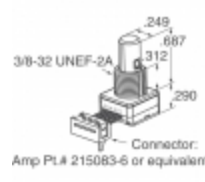
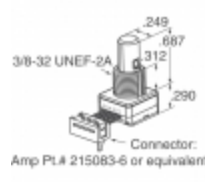
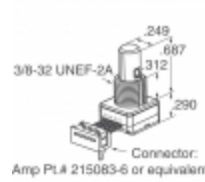
Related Products

 <p>62S11-N5-040C Manufacturers: Grayhill, Inc. Description: ROTARY ENCODER OPTICAL 32PPR In stock: 2106 pcs</p> <p>RFQ</p>	 <p>62S11-N5-120S Manufacturers: Grayhill, Inc. Description: ROTARY ENCODER OPTICAL 32PPR In stock: 1675 pcs</p> <p>RFQ</p>
 <p>62S11-N5-100C Manufacturers: Grayhill, Inc. Description: ROTARY ENCODER OPTICAL 32PPR In stock: 1789 pcs</p> <p>RFQ</p>	 <p>62S11-N5-080SH Manufacturers: Grayhill, Inc. Description: ROTARY ENCODER OPTICAL 32PPR In stock: 1942 pcs</p> <p>RFQ</p>
 <p>62S11-N4-120S Manufacturers: Grayhill, Inc. Description: ROTARY ENCODER OPTICAL 32PPR In stock: 2038 pcs</p> <p>RFQ</p>	 <p>62S11-N4-PH Manufacturers: Grayhill, Inc. Description: ROTARY ENCODER OPTICAL 32PPR In stock: 1970 pcs</p> <p>RFQ</p>
 <p>62S11-N5-025C Manufacturers: Grayhill, Inc. Description: ROTARY ENCODER OPTICAL 32PPR In stock: 2408 pcs</p> <p>RFQ</p>	 <p>62S11-N5-P Manufacturers: Grayhill, Inc. Description: ROTARY ENCODER OPTICAL 32PPR In stock: 1885 pcs</p> <p>RFQ</p>
 <p>62S11-N5-060SH Manufacturers: Grayhill, Inc. Description: ROTARY ENCODER OPTICAL 32PPR In stock: 2263 pcs</p> <p>RFQ</p>	 <p>62S11-N4-P Manufacturers: Grayhill, Inc. Description: ROTARY ENCODER OPTICAL 32PPR In stock: 1912 pcs</p> <p>RFQ</p>
 <p>62S11-N5-060C Manufacturers: Grayhill, Inc. Description: ROTARY ENCODER OPTICAL 32PPR In stock: 2164 pcs</p> <p>RFQ</p>	 <p>62S11-N5-025CH Manufacturers: Grayhill, Inc. Description: ROTARY ENCODER OPTICAL 32PPR In stock: 2083 pcs</p> <p>RFQ</p>

Copyright © 2020 Reliable Distributor of Electronic Components

E-mail: Info@infinity-electronic.com

Address: 17F, Gaylord Commercial Building, 114-118 Lockhart Road, Wan Chai, Hong Kong

