





Grayhill, Inc.

**62S11-M0-030CH**

Part Number:	62S11-M0-030CH
Manufacturer/Brand:	Grayhill, Inc.
Product description:	ROTARY ENCODER OPTICAL 32PPR
Datasheets:	 <a href="#">62S11-M0-030CH.pdf</a>
RoHS Status:	 Lead free / RoHS Compliant
Stock Condition:	2151 pcs stock
Ship From:	Hong Kong
Shipment Way:	DHL/Fedex/TNT/UPS/EMS



[REQUEST FOR QUOTATION](#)

Image may be representation. See specifications for product details.



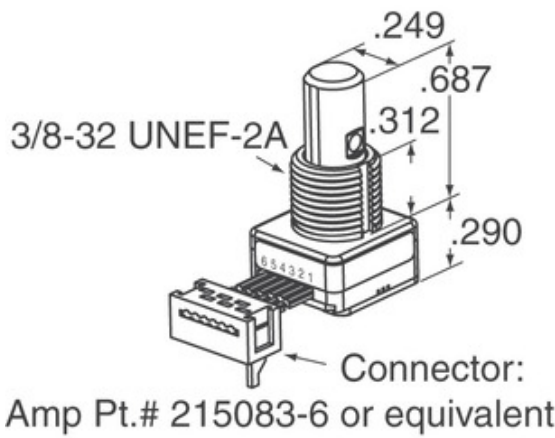

## Specifications of 62S11-M0-030CH

PART NUMBER	62S11-M0-030CH
MANUFACTURER	Grayhill, Inc.
DESCRIPTION	ROTARY ENCODER OPTICAL 32PPR
LEAD FREE STATUS / ROHS STATUS	Lead free / RoHS Compliant
QUANTITY AVAILABLE	2151 pcs
DATA SHEET	 <a href="#">62S11-M0-030CH.pdf</a>
VOLTAGE - SUPPLY	5V
TERMINATION STYLE	Cable with Connector
SERIES	62S
ROTATIONAL LIFE (CYCLES MIN)	1M
PULSES PER REVOLUTION	32
OUTPUT TYPE	Quadrature (Incremental)
OTHER NAMES	62S11M0030CH
ORIENTATION	Vertical
MOUNTING TYPE	Panel Mount
MOISTURE SENSITIVITY LEVEL (MSL)	1 (Unlimited)
LEAD FREE STATUS / ROHS STATUS	Lead free / RoHS Compliant
ENCODER TYPE	Optical
DETENT	Yes
BUILT IN SWITCH	No
ACTUATOR TYPE	1/4" Dia Flatted End

## Related Tags

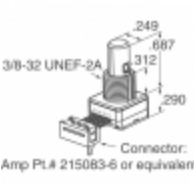
<a href="#">Grayhill, Inc. 62S11-M0-030CH</a>	<a href="#">62S11-M0-030CH Distributor</a>	<a href="#">62S11-M0-030CH Supplier</a>
<a href="#">62S11-M0-030CH Price</a>	<a href="#">62S11-M0-030CH Pictures</a>	<a href="#">62S11-M0-030CH Image</a>
<a href="#">62S11-M0-030CH PDF Datasheet</a>	<a href="#">62S11-M0-030CH Download Datasheet</a>	<a href="#">62S11-M0-030CH Datasheet</a>
<a href="#">62S11-M0-030CH Stock</a>	<a href="#">Buy 62S11-M0-030CH</a>	<a href="#">Buy Grayhill, Inc. 62S11-M0-030CH</a>
<a href="#">Grayhill, Inc. 62S11-M0-030CH</a>	<a href="#">Grayhill, Inc. Supplier</a>	<a href="#">Grayhill, Inc. Distributor</a>
<a href="#">Grayhill, Inc. 62S11-M0-030CH</a>	<a href="#">Grayhill Inc. 62S11-M0-030CH</a>	

## Related Products

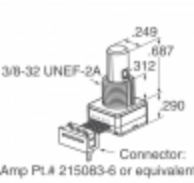
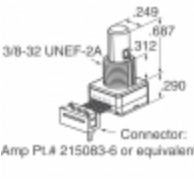
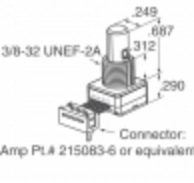
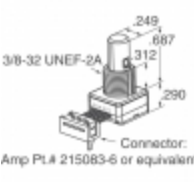
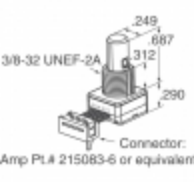
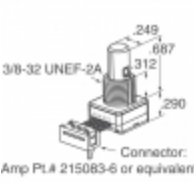
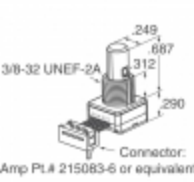
 <p><b>62S11-L9-040C</b> Manufacturers: Grayhill, Inc. Description: ROTARY ENCODER OPTICAL 32PPR In stock: 1938 pcs</p> <p><a href="#">RFQ</a></p>	 <p><b>62S11-M0-060C</b> Manufacturers: Grayhill, Inc. Description: ROTARY ENCODER OPT 32PPR 6" CBL In stock: 2289 pcs</p> <p><a href="#">RFQ</a></p>
 <p><b>62S11-M0-210SH</b> Manufacturers: Grayhill, Inc. Description: ROTARY ENCODER OPT 32PPR 20" CBL In stock: 2126 pcs</p> <p><a href="#">RFQ</a></p>	 <p><b>62S11-M0-050C</b> Manufacturers: Grayhill, Inc. Description: ROTARY ENCODER OPT 32PPR 5" CBL In stock: 2292 pcs</p> <p><a href="#">RFQ</a></p>
 <p><b>62S11-M0-040CH</b> Manufacturers: Grayhill, Inc. Description: ROTARY ENCODER OPT 32PPR 2" CBL In stock: 1915 pcs</p> <p><a href="#">RFQ</a></p>	 <p><b>62S11-M0-060CH</b> Manufacturers: Grayhill, Inc. Description: ROTARY ENCODER OPTICAL 32PPR In stock: 1968 pcs</p> <p><a href="#">RFQ</a></p>
 <p><b>62S11-M0-020C</b> Manufacturers: Grayhill, Inc. Description: ROTARY ENCODER OPT 32PPR 2" CBL In stock: 1812 pcs</p> <p><a href="#">RFQ</a></p>	 <p><b>62S11-M0-020SH</b> Manufacturers: Grayhill, Inc. Description: ROTARY ENCODER OPT 32PPR 2" CBL In stock: 2051 pcs</p> <p><a href="#">RFQ</a></p>
 <p><b>62S11-L9-PH</b> Manufacturers: Grayhill, Inc. Description: ROTARY ENCODER OPTICAL 32PPR In stock: 1972 pcs</p> <p><a href="#">RFQ</a></p>	 <p><b>62S11-M0-200S</b> Manufacturers: Grayhill, Inc. Description: ROTARY ENCODER OPTICAL 32PPR In stock: 2199 pcs</p> <p><a href="#">RFQ</a></p>
 <p><b>62S11-L9-020SH</b> Manufacturers: Grayhill, Inc. Description: ROTARY ENCODER OPTICAL 32PPR In stock: 1952 pcs</p> <p><a href="#">RFQ</a></p>	 <p><b>62S11-L9-020S</b> Manufacturers: Grayhill, Inc. Description: ROTARY ENCODER OPTICAL 32PPR In stock: 2134 pcs</p> <p><a href="#">RFQ</a></p>

Copyright © 2020 Reliable Distributor of Electronic Components

E-mail: [Info@infinity-electronic.com](mailto:Info@infinity-electronic.com)

Address: 17F, Gaylord Commercial Building, 114-118 Lockhart Road, Wan Chai, Hong Kong

