

# BAS19L, BAS20L, BAS21L, BAS21DW5

## High Voltage Switching Diode

### Features

- These Devices are Pb-Free, Halogen Free/BFR Free and are RoHS Compliant
- S and NSV Prefixes for Automotive and Other Applications Requiring Unique Site and Control Change Requirements; AEC-Q101 Qualified and PPAP Capable

### MAXIMUM RATINGS

Rating	Symbol	Value	Unit
Continuous Reverse Voltage	$V_R$	120 200 250	Vdc
Repetitive Peak Reverse Voltage	$V_{RRM}$	120 200 250	Vdc
Continuous Forward Current	$I_F$	200	mAdc
Peak Forward Surge Current (1/2 Cycle, Sine Wave, 60 Hz)	$I_{FSM}$	2	A
Repetitive Peak Forward Current (Pulse Train: $T_{ON} = 1$ s, $T_{OFF} = 0.5$ s)	$I_{FRM}$	0.6	A
Junction and Storage Temperature Range	$T_J, T_{stg}$	-55 to +150	°C
Power Dissipation (Note 1)	$P_D$	385	mW
Electrostatic Discharge	ESD	HM < 500 MM < 400	V

Stresses exceeding those listed in the Maximum Ratings table may damage the device. If any of these limits are exceeded, device functionality should not be assumed, damage may occur and reliability may be affected.

1. Mounted on FR-5 Board = 1.0 x 0.75 x 0.062 in.



ON Semiconductor®

[www.onsemi.com](http://www.onsemi.com)

## HIGH VOLTAGE SWITCHING DIODE

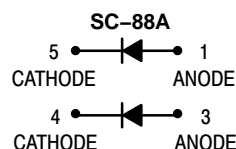
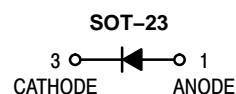

### MARKING DIAGRAMS

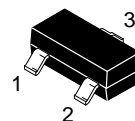

SOT-23 (TO-236)  
CASE 318  
STYLE 8

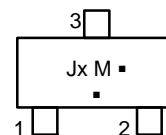

SC-88A (SOT-353)  
CASE 419A

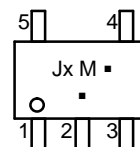

x = P, R, or S  
P = BAS19L  
R = BAS20L  
S = BAS21L or BAS21DW5  
M = Date Code  
▪ = Pb-Free Package

(Note: Microdot may be in either location)

\*Date Code orientation and/or overbar may vary depending upon the manufacturing location.

### ORDERING INFORMATION

See detailed ordering and shipping information in the package dimensions section on page 4 of this data sheet.

# BAS19L, BAS20L, BAS21L, BAS21DW5

## Thermal Characteristics (SOT-23)

Characteristic	Symbol	Max	Unit
Total Device Dissipation FR-5 Board (Note 2) $T_A = 25^\circ\text{C}$ Derate above $25^\circ\text{C}$	$P_D$	225	mW
		1.8	mW/ $^\circ\text{C}$
Thermal Resistance Junction-to-Ambient (SOT-23)	$R_{\theta JA}$	556	$^\circ\text{C}/\text{W}$
Total Device Dissipation Alumina Substrate (Note 3) $T_A = 25^\circ\text{C}$ Derate above $25^\circ\text{C}$	$P_D$	300	mW
		2.4	mW/ $^\circ\text{C}$
Thermal Resistance Junction-to-Ambient	$R_{\theta JA}$	417	$^\circ\text{C}/\text{W}$
Junction and Storage Temperature Range	$T_J, T_{stg}$	-55 to +150	$^\circ\text{C}$

## Thermal Characteristics (SC-88A)

Characteristic	Symbol	Max	Unit
Power Dissipation (Note 4)	$P_D$	385	mW
Thermal Resistance – Junction-to-Ambient Derate Above $25^\circ\text{C}$	$R_{\theta JA}$	328	$^\circ\text{C}/\text{W}$
		3.0	mW/ $^\circ\text{C}$
Maximum Junction Temperature	$T_{Jmax}$	150	$^\circ\text{C}$
Operating Junction and Storage Temperature Range	$T_J, T_{stg}$	-55 to +150	$^\circ\text{C}$

2. FR-5 = 1.0 × 0.75 × 0.062 in.

3. Alumina = 0.4 × 0.3 × 0.024 in. 99.5% alumina.

4. Mounted on FR-5 Board = 1.0 × 0.75 × 0.062 in.

## Electrical Characteristics ( $T_A = 25^\circ\text{C}$ unless otherwise noted)

Characteristic	Symbol	Min	Max	Unit	
Reverse Voltage Leakage Current ( $V_R = 100\text{ Vdc}$ ) ( $V_R = 150\text{ Vdc}$ ) ( $V_R = 200\text{ Vdc}$ ) ( $V_R = 100\text{ Vdc}, T_J = 150^\circ\text{C}$ ) ( $V_R = 150\text{ Vdc}, T_J = 150^\circ\text{C}$ ) ( $V_R = 200\text{ Vdc}, T_J = 150^\circ\text{C}$ )	$I_R$	-	0.1	$\mu\text{Adc}$	
			BAS19	0.1	
			BAS20	0.1	
			BAS21	100	
			BAS19	100	
			BAS20	100	
Reverse Breakdown Voltage ( $I_{BR} = 100\ \mu\text{Adc}$ ) ( $I_{BR} = 100\ \mu\text{Adc}$ ) ( $I_{BR} = 100\ \mu\text{Adc}$ )	$V_{(BR)}$	-	120	Vdc	
			BAS19	200	
			BAS20	250	
Forward Voltage ( $I_F = 100\text{ mAdc}$ ) ( $I_F = 200\text{ mAdc}$ )	$V_F$	-	1.0	Vdc	
			BAS19	1.25	
Diode Capacitance ( $V_R = 0, f = 1.0\text{ MHz}$ )	$C_D$	-	5.0	pF	
Reverse Recovery Time ( $I_F = I_R = 30\text{ mAdc}, I_{R(REC)} = 3.0\text{ mAdc}, R_L = 100$ )	$t_{rr}$	-	50	ns	

Product parametric performance is indicated in the Electrical Characteristics for the listed test conditions, unless otherwise noted. Product performance may not be indicated by the Electrical Characteristics if operated under different conditions.

# BAS19L, BAS20L, BAS21L, BAS21DW5

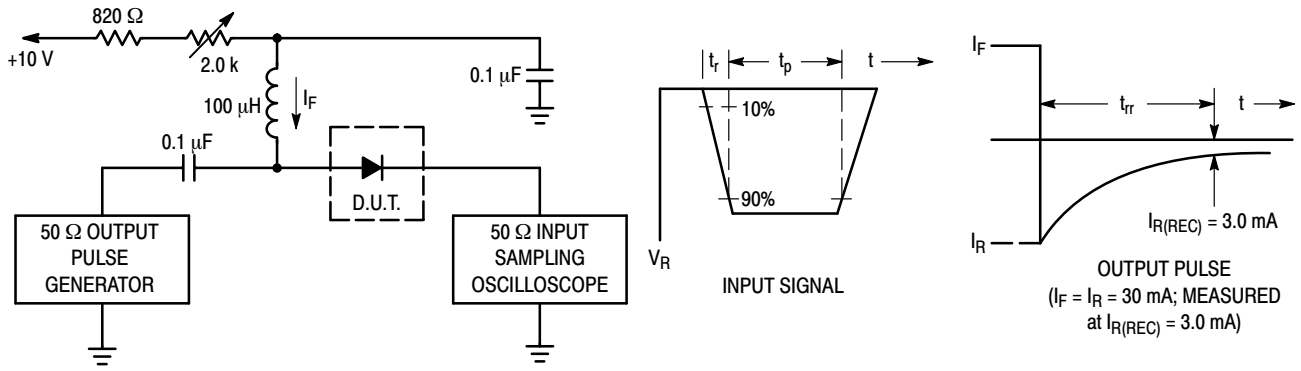

- Notes: 1. A 2.0 kΩ variable resistor adjusted for a Forward Current ( $I_F$ ) of 30 mA.  
 2. Input pulse is adjusted so  $I_{R(\text{peak})}$  is equal to 30 mA.  
 3.  $t_p \gg t_{rr}$

Figure 1. Recovery Time Equivalent Test Circuit

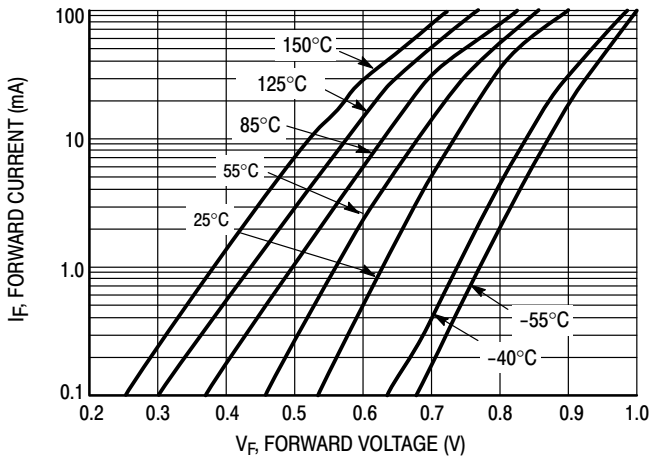

Figure 2.  $V_F$  vs.  $I_F$

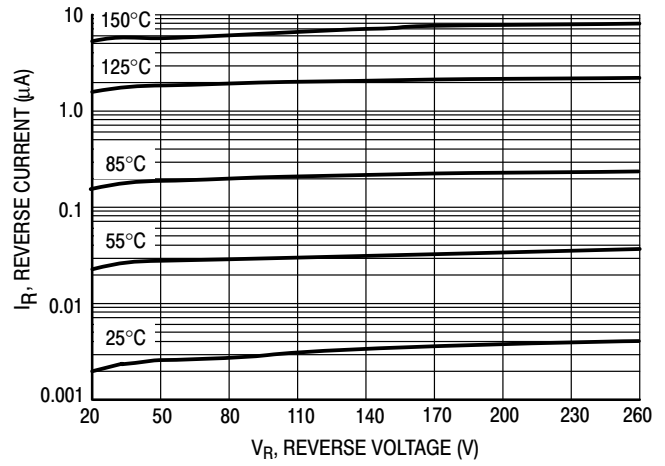

Figure 3.  $I_R$  vs.  $V_R$

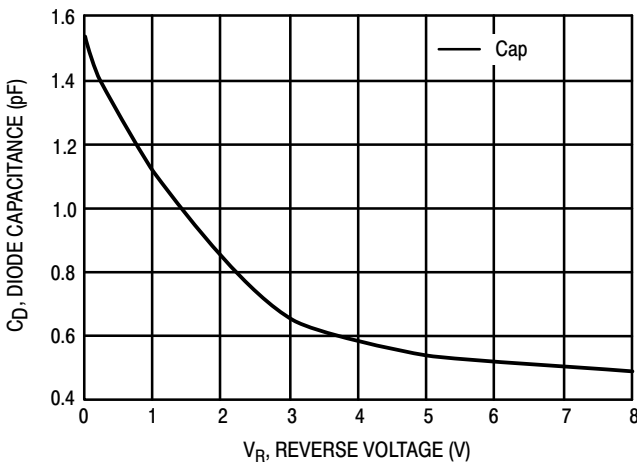

Figure 4. Capacitance

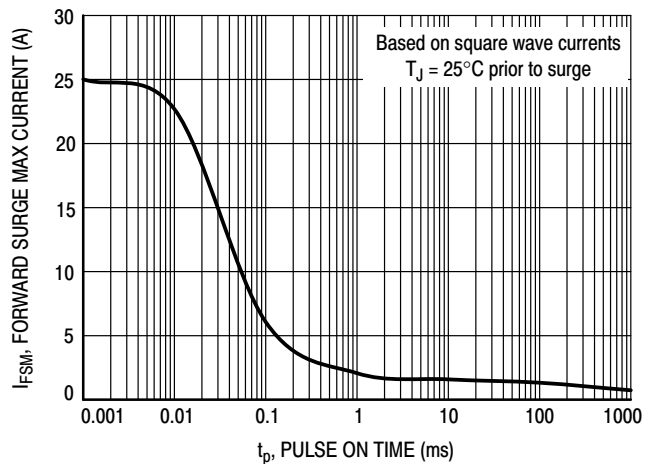

Figure 5. Forward Surge Current

## BAS19L, BAS20L, BAS21L, BAS21DW5

### ORDERING INFORMATION

Device	Package	Shipping†
BAS19LT1G	SOT-23 (Pb-Free)	3000 / Tape & Reel
BAS19LT3G	SOT-23 (Pb-Free)	10000 / Tape & Reel
NSVBAS19LT1G*	SOT-23 (Pb-Free)	3000 / Tape & Reel
BAS20LT1G	SOT-23 (Pb-Free)	3000 / Tape & Reel
BAS20LT3G	SOT-23 (Pb-Free)	10000 / Tape & Reel
NSVBAS20LT3G*	SOT-23 (Pb-Free)	10000 / Tape & Reel
SBAS20LT1G*	SOT-23 (Pb-Free)	3000 / Tape & Reel
BAS21LT1G	SOT-23 (Pb-Free)	3000 / Tape & Reel
SBAS21LT1G*	SOT-23 (Pb-Free)	3000 / Tape & Reel
BAS21LT3G	SOT-23 (Pb-Free)	10000 / Tape & Reel
SBAS21LT3G*	SOT-23 (Pb-Free)	10000 / Tape & Reel
BAS21DW5T1G	SC-88A (Pb-Free)	3000 / Tape & Reel
SBAS21DW5T1G*	SC-88A (Pb-Free)	3000 / Tape & Reel
SBAS21DW5T3G*	SC-88A (Pb-Free)	10000 / Tape & Reel

†For information on tape and reel specifications, including part orientation and tape sizes, please refer to our Tape and Reel Packaging Specifications Brochure, BRD8011/D.

\*S and NSV Prefixes for Automotive and Other Applications Requiring Unique Site and Control Change Requirements; AEC-Q101 Qualified and PPAP Capable.

# BAS19L, BAS20L, BAS21L, BAS21DW5

## PACKAGE DIMENSIONS

SOT-23 (TO-236)  
CASE 318-08  
ISSUE AR

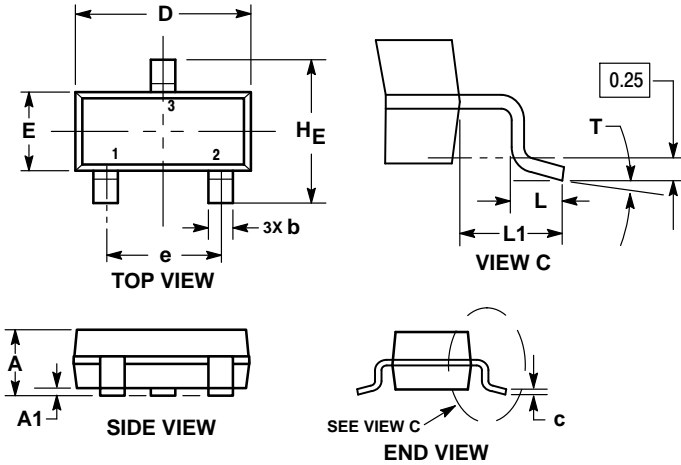

NOTES:

1. DIMENSIONING AND TOLERANCING PER ASME Y14.5M, 1994.
2. CONTROLLING DIMENSION: MILLIMETERS.
3. MAXIMUM LEAD THICKNESS INCLUDES LEAD FINISH. MINIMUM LEAD THICKNESS IS THE MINIMUM THICKNESS OF THE BASE MATERIAL.
4. DIMENSIONS D AND E DO NOT INCLUDE MOLD FLASH, PROTRUSIONS, OR GATE BURRS.

DIM	MILLIMETERS			INCHES		
	MIN	NOM	MAX	MIN	NOM	MAX
A	0.89	1.00	1.11	0.035	0.039	0.044
A1	0.01	0.06	0.10	0.000	0.002	0.004
b	0.37	0.44	0.50	0.015	0.017	0.020
c	0.08	0.14	0.20	0.003	0.006	0.008
D	2.80	2.90	3.04	0.110	0.114	0.120
E	1.20	1.30	1.40	0.047	0.051	0.055
e	1.78	1.90	2.04	0.070	0.075	0.080
L	0.30	0.43	0.55	0.012	0.017	0.022
L1	0.35	0.54	0.69	0.014	0.021	0.027
HE	2.10	2.40	2.64	0.083	0.094	0.104
T	0°	—	10°	0°	—	10°

STYLE 8:

- PIN 1: ANODE
- NO CONNECTION
- CATHODE

### RECOMMENDED SOLDERING FOOTPRINT

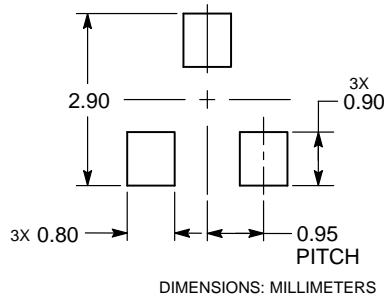

# BAS19L, BAS20L, BAS21L, BAS21DW5

## PACKAGE DIMENSIONS

SC-88A (SC-70-5/SOT-353)  
CASE 419A-02  
ISSUE L

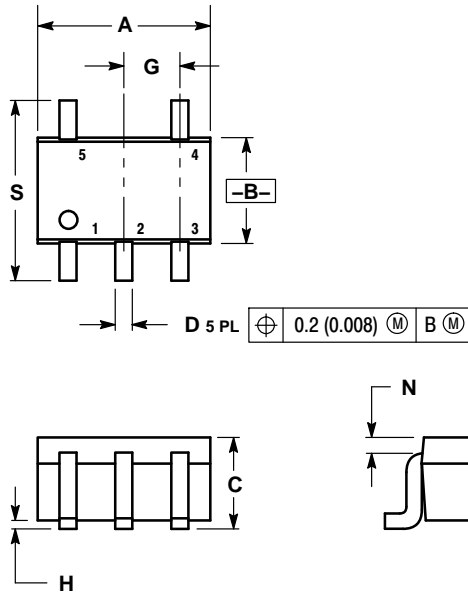

**NOTES:**

1. DIMENSIONING AND TOLERANCING PER ANSI Y14.5M, 1982.
2. CONTROLLING DIMENSION: INCH.
3. 419A-01 OBSOLETE. NEW STANDARD 419A-02.
4. DIMENSIONS A AND B DO NOT INCLUDE MOLD FLASH, PROTRUSIONS, OR GATE BURRS.

DIM	INCHES		MILLIMETERS	
	MIN	MAX	MIN	MAX
A	0.071	0.087	1.80	2.20
B	0.045	0.053	1.15	1.35
C	0.031	0.043	0.80	1.10
D	0.004	0.012	0.10	0.30
G	0.026 BSC		0.65 BSC	
H	---	0.004	---	0.10
J	0.004	0.010	0.10	0.25
K	0.004	0.012	0.10	0.30
N	0.008 REF		0.20 REF	
S	0.079	0.087	2.00	2.20

## SOLDER FOOTPRINT

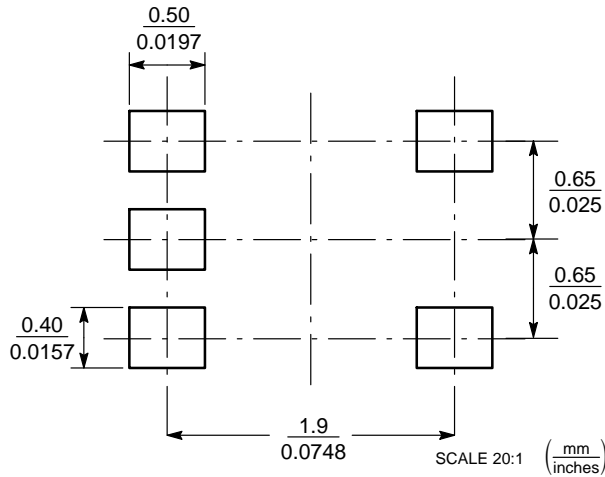

ON Semiconductor and are trademarks of Semiconductor Components Industries, LLC dba ON Semiconductor or its subsidiaries in the United States and/or other countries. ON Semiconductor owns the rights to a number of patents, trademarks, copyrights, trade secrets, and other intellectual property. A listing of ON Semiconductor's product/patent coverage may be accessed at [www.onsemi.com/site/pdf/Patent-Marking.pdf](http://www.onsemi.com/site/pdf/Patent-Marking.pdf). ON Semiconductor reserves the right to make changes without further notice to any products herein. ON Semiconductor makes no warranty, representation or guarantee regarding the suitability of its products for any particular purpose, nor does ON Semiconductor assume any liability arising out of the application or use of any product or circuit, and specifically disclaims any and all liability, including without limitation special, consequential or incidental damages. Buyer is responsible for its products and applications using ON Semiconductor products, including compliance with all laws, regulations and safety requirements or standards, regardless of any support or applications information provided by ON Semiconductor. "Typical" parameters which may be provided in ON Semiconductor data sheets and/or specifications can and do vary in different applications and actual performance may vary over time. All operating parameters, including "Typicals" must be validated for each customer application by customer's technical experts. ON Semiconductor does not convey any license under its patent rights nor the rights of others. ON Semiconductor products are not designed, intended, or authorized for use as a critical component in life support systems or any FDA Class 3 medical devices or medical devices with a same or similar classification in a foreign jurisdiction or any devices intended for implantation in the human body. Should Buyer purchase or use ON Semiconductor products for any such unintended or unauthorized application, Buyer shall indemnify and hold ON Semiconductor and its officers, employees, subsidiaries, affiliates, and distributors harmless against all claims, costs, damages, and expenses, and reasonable attorney fees arising out of, directly or indirectly, any claim of personal injury or death associated with such unintended or unauthorized use, even if such claim alleges that ON Semiconductor was negligent regarding the design or manufacture of the part. ON Semiconductor is an Equal Opportunity/Affirmative Action Employer. This literature is subject to all applicable copyright laws and is not for resale in any manner.

## PUBLICATION ORDERING INFORMATION

**LITERATURE FULFILLMENT:**  
Literature Distribution Center for ON Semiconductor  
19521 E. 32nd Pkwy, Aurora, Colorado 80011 USA  
**Phone:** 303-675-2175 or 800-344-3860 Toll Free USA/Canada  
**Fax:** 303-675-2176 or 800-344-3867 Toll Free USA/Canada  
**Email:** [orderlit@onsemi.com](mailto:orderlit@onsemi.com)

**N. American Technical Support:** 800-282-9855 Toll Free  
USA/Canada  
**Europe, Middle East and Africa Technical Support:**  
Phone: 421 33 790 2910  
**Japan Customer Focus Center**  
Phone: 81-3-5817-1050

**ON Semiconductor Website:** [www.onsemi.com](http://www.onsemi.com)  
**Order Literature:** <http://www.onsemi.com/orderlit>  
For additional information, please contact your local Sales Representative