

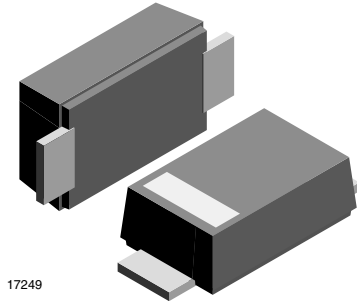

Schottky Rectifier Surface Mount



17249

MECHANICAL DATA

Case: DO-219AB (SMF)

Polarity: color band denotes cathode end

Weight: approx. 15 mg

Packaging codes / options:

18/10K per 13" reel (8 mm tape), 50K/box
08/3K per 7" reel (8 mm tape), 30K/box

Int. construction: single

FEATURES

- For surface mounted applications
- Low-profile package
- Ideal for automated placement
- Low power loss, high efficiency
- Oxide planar chip junction
- Meets MSL level 1, per J-STD-020, LF maximum peak of 260 °C
- Meets JESD 201 class 2 whisker test
- Wave and reflow solderable
- AEC-Q101 qualified
- Material categorization: for definitions of compliance please see www.vishay.com/doc?99912



RoHS
COMPLIANT
HALOGEN
FREE

PARTS TABLE			
PART	ORDERING CODE	MARKING	REMARKS
SL02-M	SL02-M-18 or SL02-M-08	U2	Tape and reel
SL03-M	SL03-M-18 or SL03-M-08	U3	Tape and reel

ABSOLUTE MAXIMUM RATINGS (T _{amb} = 25 °C, unless otherwise specified)					
PARAMETER	TEST CONDITION	PART	SYMBOL	VALUE	UNIT
Maximum repetitive peak reverse voltage		SL02-M	V _{RRM}	20	V
		SL03-M	V _{RRM}	30	V
Maximum RMS voltage		SL02-M	V _{RMS}	14	V
		SL03-M	V _{RMS}	21	V
Maximum DC blocking voltage		SL02-M	V _{DC}	20	V
		SL03-M	V _{DC}	30	V
Maximum average forward rectified current	T _{tp} = 109 °C		I _{F(AV)}	1.1	A
Peak forward surge current 8.3 ms single half sine-wave			I _{FSM}	40	A

THERMAL CHARACTERISTICS (T _{amb} = 25 °C, unless otherwise specified)				
PARAMETER	TEST CONDITION	SYMBOL	VALUE	UNIT
Thermal resistance junction to ambient air ⁽¹⁾		R _{thJA}	180	K/W
Maximum operating junction temperature		T _j	125	°C
Storage temperature range		T _{stg}	-55 to +150	°C

Note

⁽¹⁾ Mounted on epoxy substrate with 3 mm x 3 mm Cu pads (≥ 40 μm thick)



ELECTRICAL CHARACTERISTICS ($T_{amb} = 25\text{ }^{\circ}\text{C}$, unless otherwise specified)							
PARAMETER	TEST CONDITION	PART	SYMBOL	MIN.	TYP.	MAX.	UNIT
Instantaneous forward voltage	$I_F = 0.5\text{ A}$ ⁽¹⁾	SL02-M	V_F		0.360	0.385	V
		SL03-M	V_F		0.395	0.43	V
Typical instantaneous forward voltage	$I_F = 1.1\text{ A}$	SL02-M	V_F		0.420		V
		SL03-M	V_F		0.450		V
Maximum DC reverse current at rated DC blocking voltage	$T_A = 25\text{ }^{\circ}\text{C}$	SL02-M	I_R			250	μA
	$T_A = 100\text{ }^{\circ}\text{C}$	SL02-M	I_R			8	mA
	$T_A = 25\text{ }^{\circ}\text{C}$	SL03-M	I_R			130	μA
	$T_A = 100\text{ }^{\circ}\text{C}$	SL03-M	I_R			6	mA
Reverse recovery time		SL02-M	t_{rr}			< 10	ns
		SL03-M	t_{rr}			< 10	ns

Note

(1) Pulse test: 300 μs pulse width, 1 % duty cycle

TYPICAL CHARACTERISTICS ($T_{amb} = 25\text{ }^{\circ}\text{C}$, unless otherwise specified)

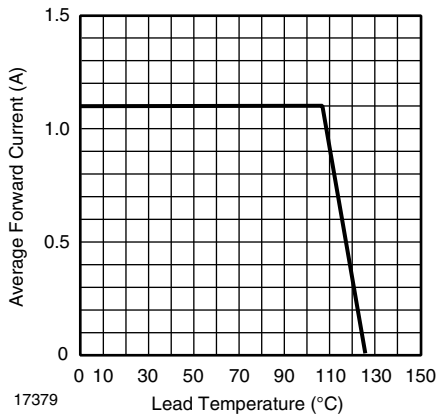

Fig. 1 - Forward Current Derating Curve

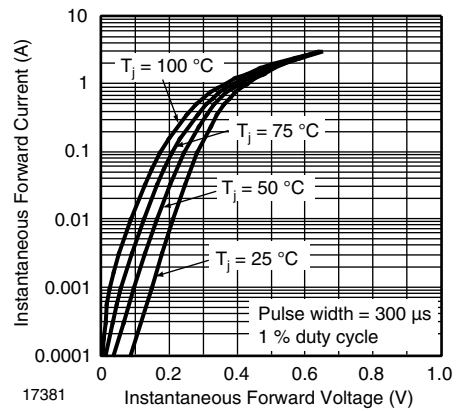

Fig. 3 - Typical Instantaneous Forward Characteristics - SL02

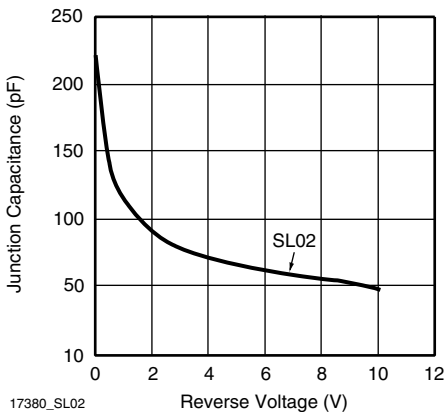

Fig. 2 - Typical Junction Capacitance

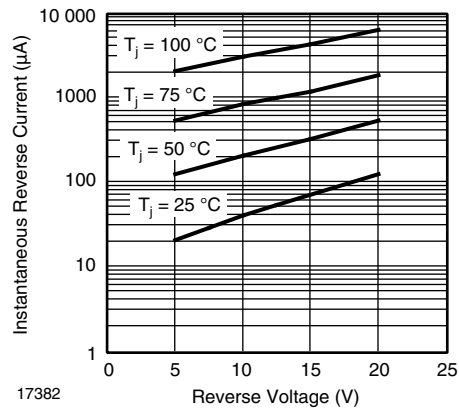

Fig. 4 - Typical Reverse Current Characteristics - SL02

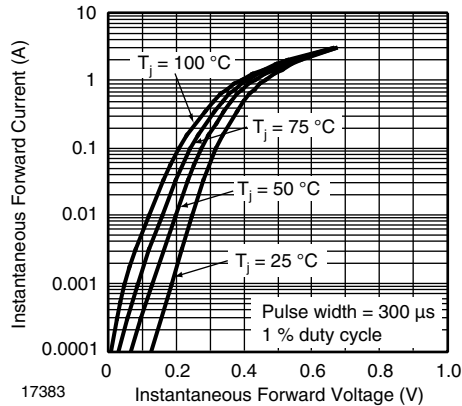

Fig. 5 - Typical Instantaneous Forward Characteristics - SL03

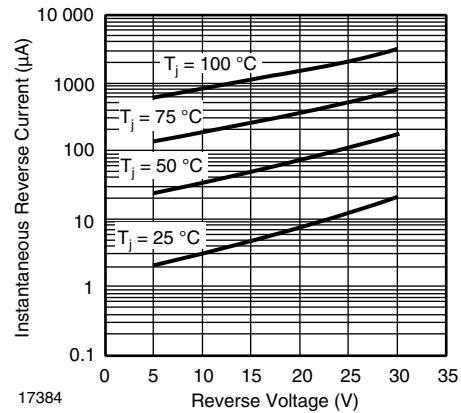
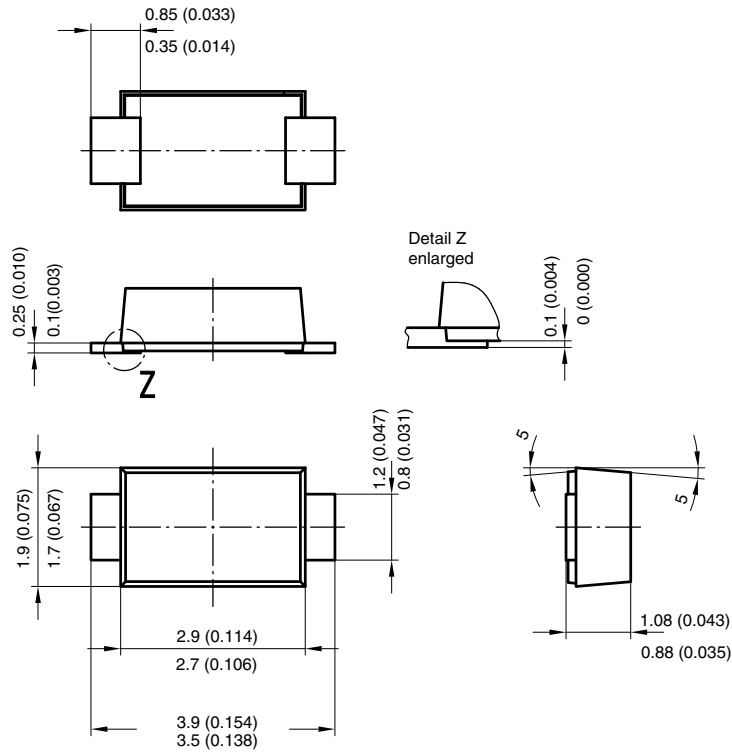
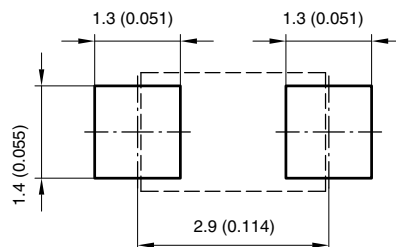

Fig. 6 - Typical Reverse Current Characteristics - SL03

PACKAGE DIMENSIONS in millimeters (inches): **DO-219AB (SMF)**



Foot print recommendation:



Created - Date: 15. February 2005
 Rev. 3 - Date: 13. March 2007
 Document no.:S8-V-3915.01-001 (4)
 17247

BLISTERTAPE DIMENSIONS in millimeters: DO-219 AB (SMF)

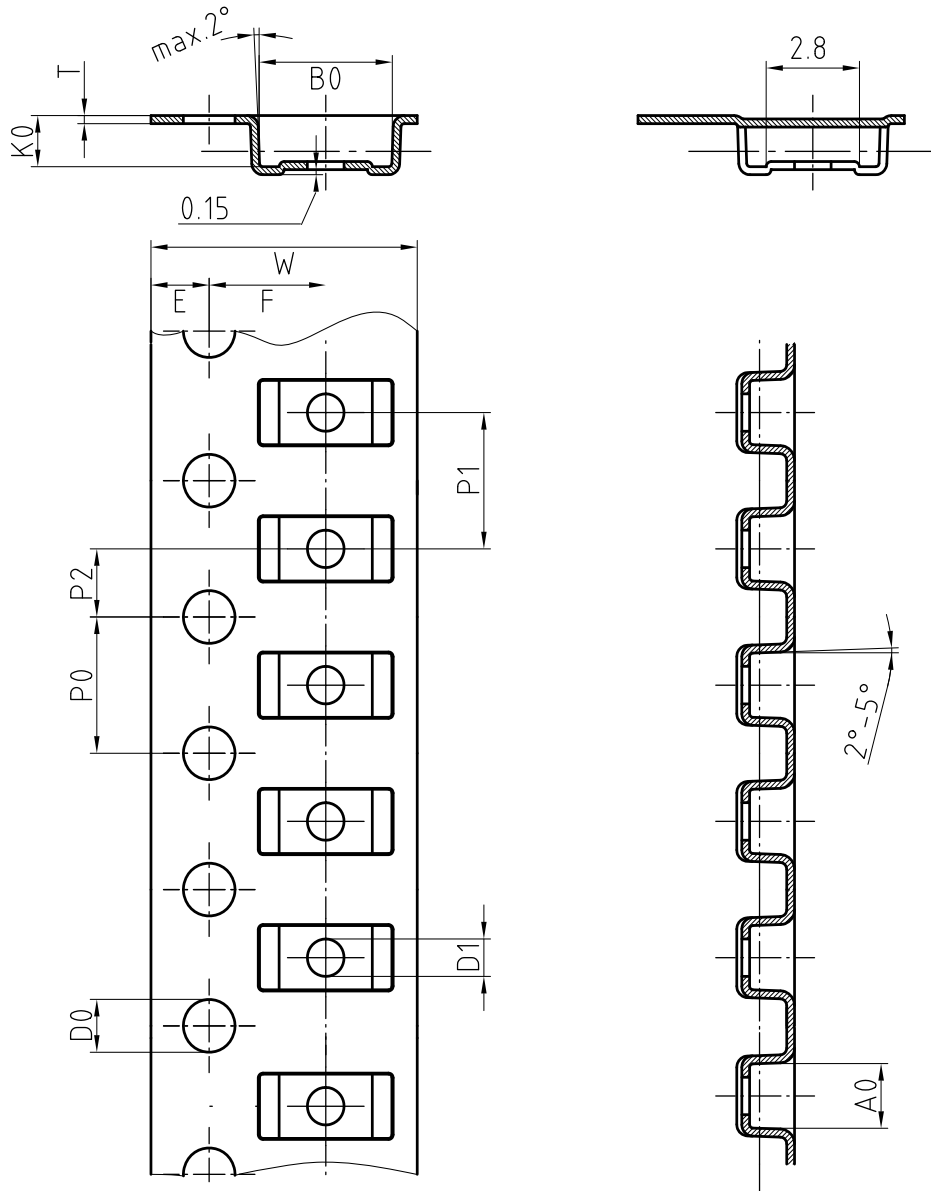

Mat:	A0	B0	K0	W	T	P0	P2	P1	D0	D1	E	F
PS	1.9	4.0	1.5	8.0	0.235	4.0	2.0	4.0	1.5	1	1.75	3.5

Document-No.: S8-V-3717.02-001 (3)

18513



ORIENTATION IN CARRIER TAPE - SMF

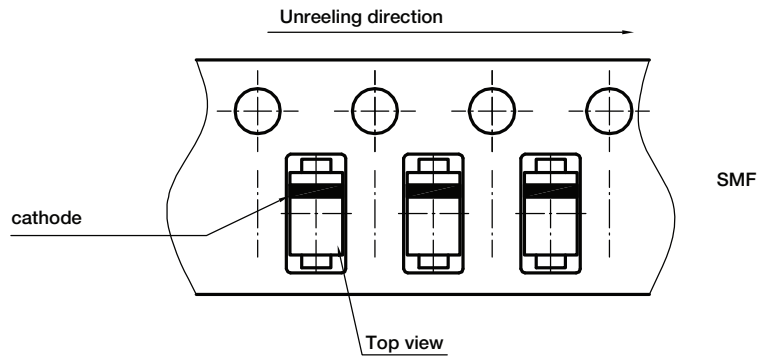

Document no.: S8-V-3717.02-003 (4)
Created - Date: 09. Feb. 2010
22670



Disclaimer

ALL PRODUCT, PRODUCT SPECIFICATIONS AND DATA ARE SUBJECT TO CHANGE WITHOUT NOTICE TO IMPROVE RELIABILITY, FUNCTION OR DESIGN OR OTHERWISE.

Vishay Intertechnology, Inc., its affiliates, agents, and employees, and all persons acting on its or their behalf (collectively, "Vishay"), disclaim any and all liability for any errors, inaccuracies or incompleteness contained in any datasheet or in any other disclosure relating to any product.

Vishay makes no warranty, representation or guarantee regarding the suitability of the products for any particular purpose or the continuing production of any product. To the maximum extent permitted by applicable law, Vishay disclaims (i) any and all liability arising out of the application or use of any product, (ii) any and all liability, including without limitation special, consequential or incidental damages, and (iii) any and all implied warranties, including warranties of fitness for particular purpose, non-infringement and merchantability.

Statements regarding the suitability of products for certain types of applications are based on Vishay's knowledge of typical requirements that are often placed on Vishay products in generic applications. Such statements are not binding statements about the suitability of products for a particular application. It is the customer's responsibility to validate that a particular product with the properties described in the product specification is suitable for use in a particular application. Parameters provided in datasheets and / or specifications may vary in different applications and performance may vary over time. All operating parameters, including typical parameters, must be validated for each customer application by the customer's technical experts. Product specifications do not expand or otherwise modify Vishay's terms and conditions of purchase, including but not limited to the warranty expressed therein.

Except as expressly indicated in writing, Vishay products are not designed for use in medical, life-saving, or life-sustaining applications or for any other application in which the failure of the Vishay product could result in personal injury or death. Customers using or selling Vishay products not expressly indicated for use in such applications do so at their own risk. Please contact authorized Vishay personnel to obtain written terms and conditions regarding products designed for such applications.

No license, express or implied, by estoppel or otherwise, to any intellectual property rights is granted by this document or by any conduct of Vishay. Product names and markings noted herein may be trademarks of their respective owners.